

Dalet

D

ד

דָּלֶת

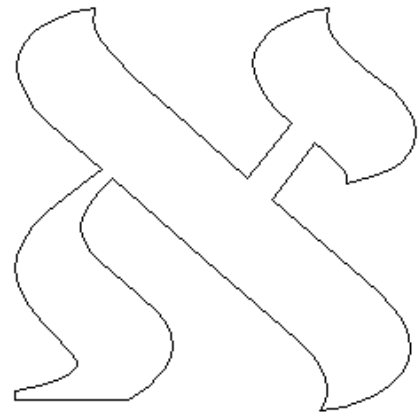

Aleph

א

אָלֶפֶת

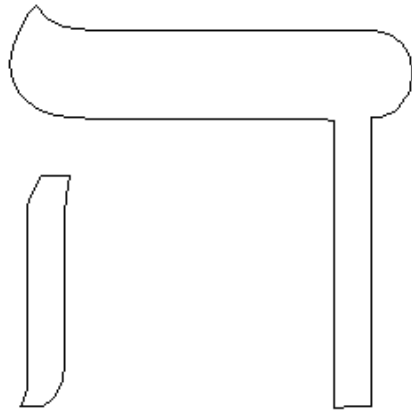

Hei

H

ה

הֵי

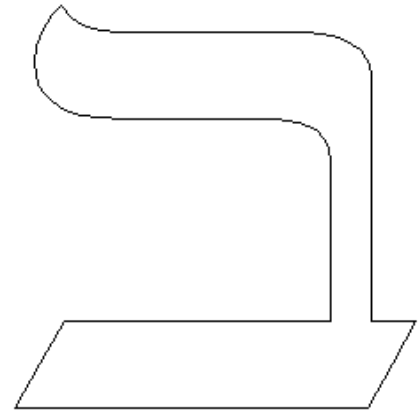

Bet, Vet

B,V

ב

בֵּית

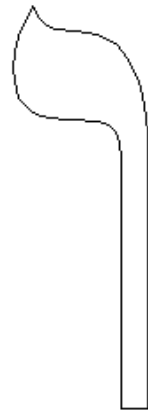

Vav

V

ו

וָו

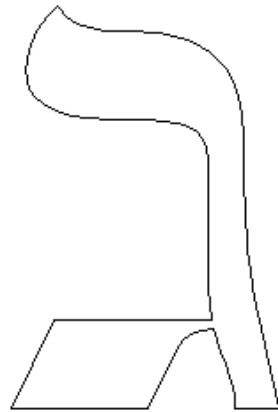

Gimel

G

ג

גִּמֵּל



Yod

I, Y

י

יוד

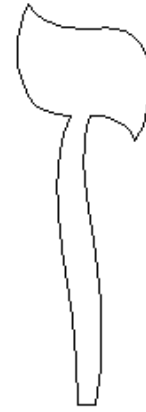

Zain

Z

ז

זין

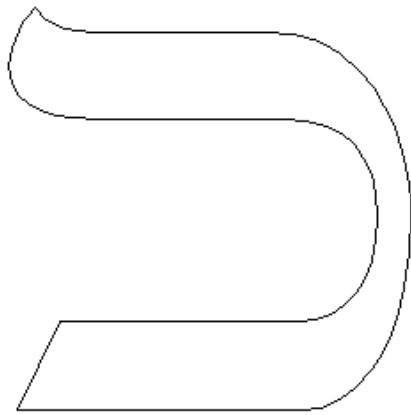

Kaf, Chaf

K, Ch

כ

כף

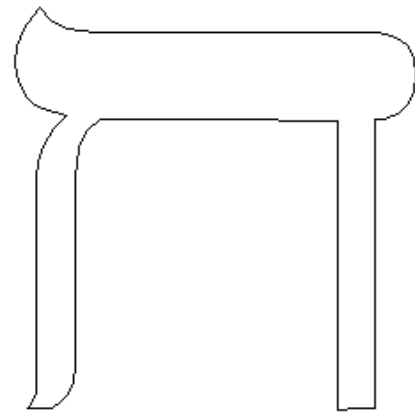

Chet

CH

ח

חית

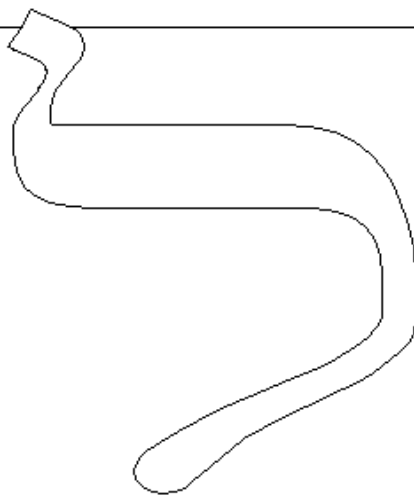

Lamed

L

ל

למד

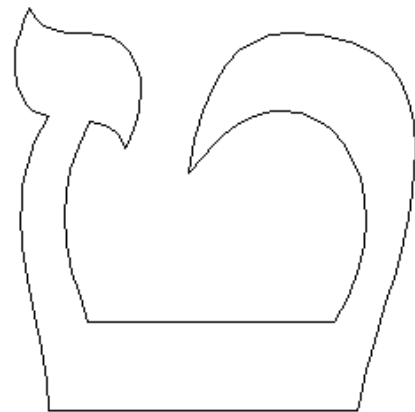

Tet

T

ט

טית

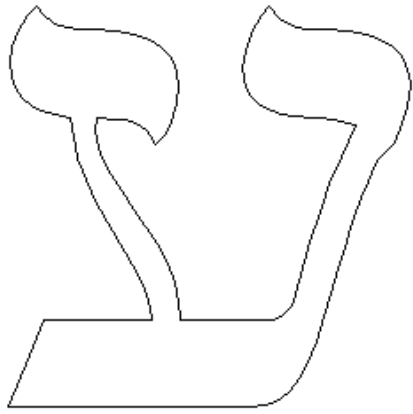

Ayin

ע

עין

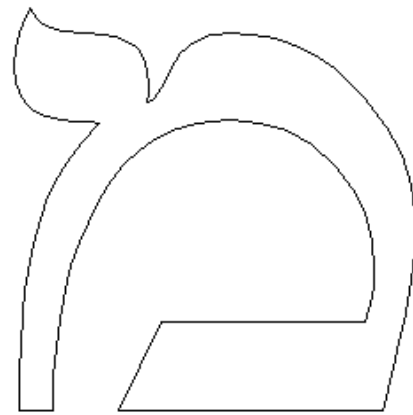

Mem

M

מ

מם

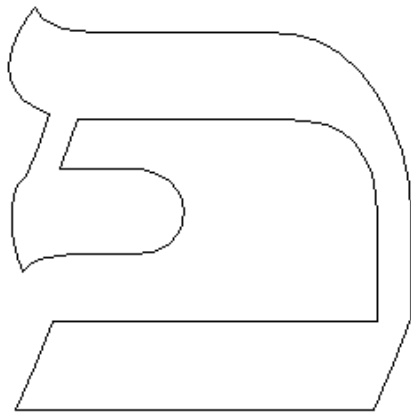

Fe, Pe

F,P

פ

פם

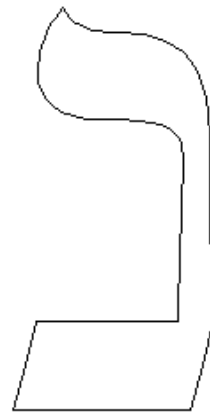

Nun

N

נ

נן

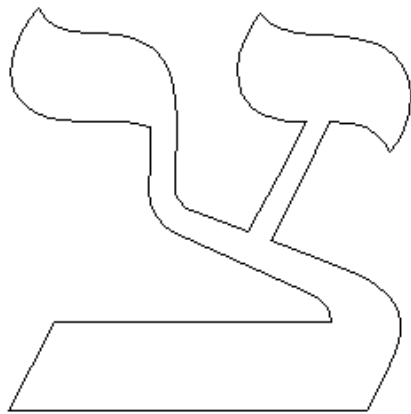

TZadi

TZ

צ

צדי

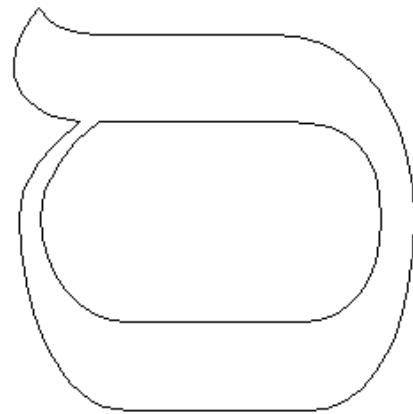

Samech

S

ס

סם

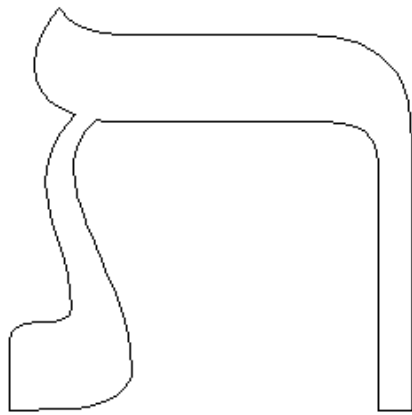

Tav

T

ת

תָּ = תַּ

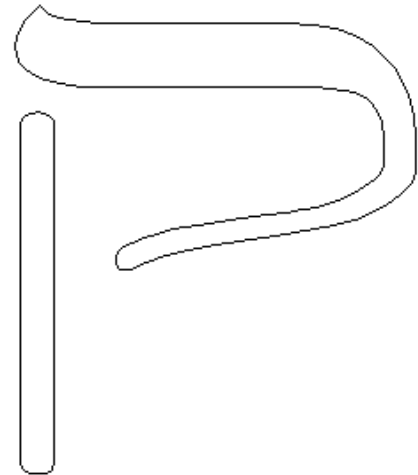

Kof

K,Q

ק

קוּף = קוֹף

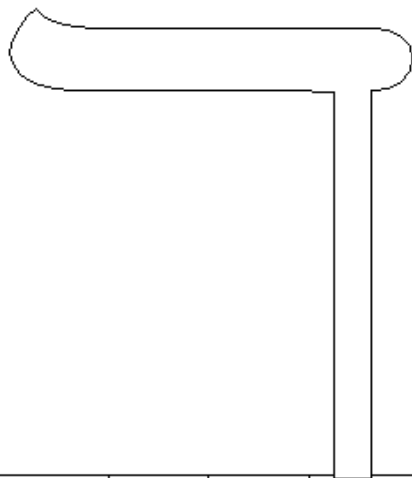

Kaf, Chaf

K,Ch

כ

כָּ = כַּ

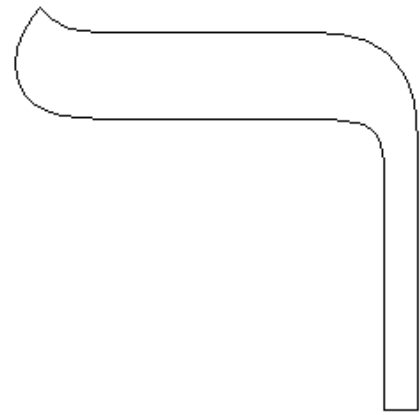

Reish

R

ר

רֵישׁ = רֵישׁ

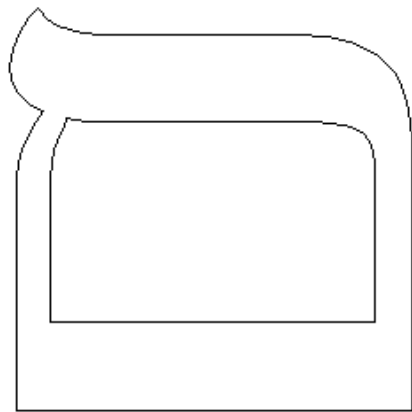

Mem

M

מ

מָ = מַ

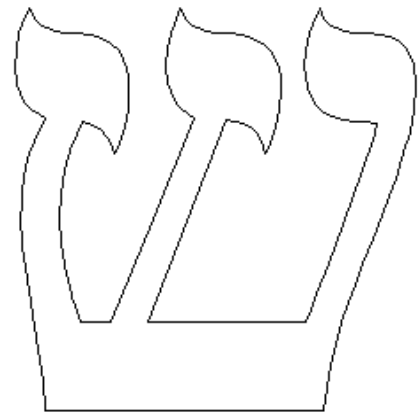

Sin, Shin

S,Sh

ש

שֵׁן = שֵׁן

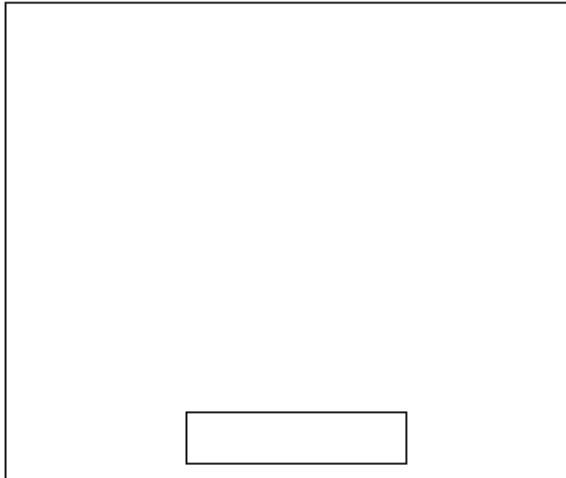

Patach	A	-	פָּתַח
--------	---	---	--------

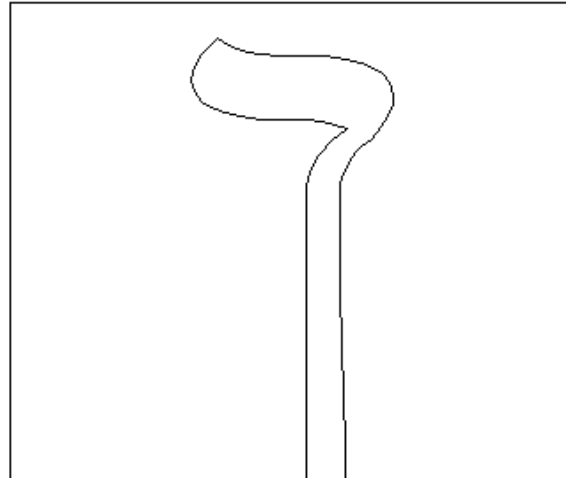

Nun	N	ן	נ = נָ
-----	---	---	--------

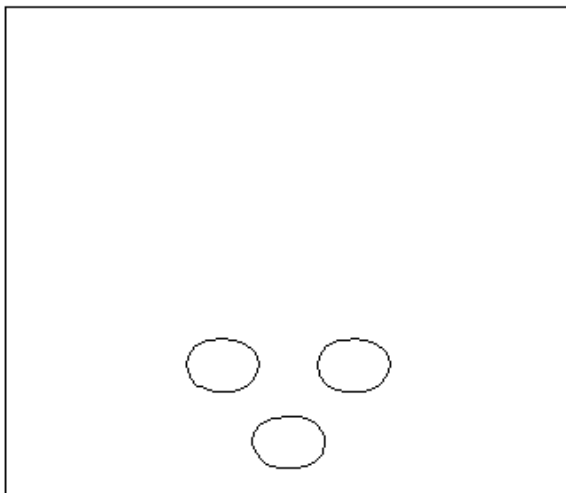

Segol	E	ֿ	סֶגוּל
-------	---	---	--------

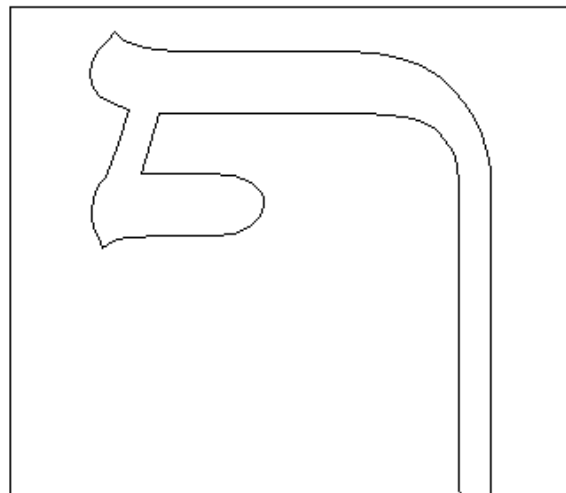

Fe, Pe	F,P	פֿ	פ = פֶּ
--------	-----	----	---------

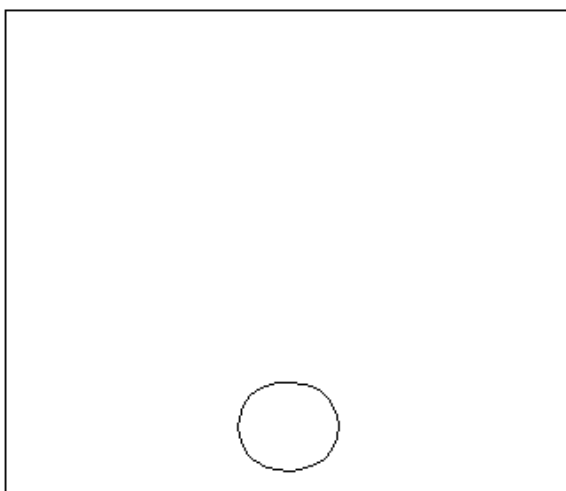

Chirik	I	ֿ	חִירִיק
--------	---	---	---------

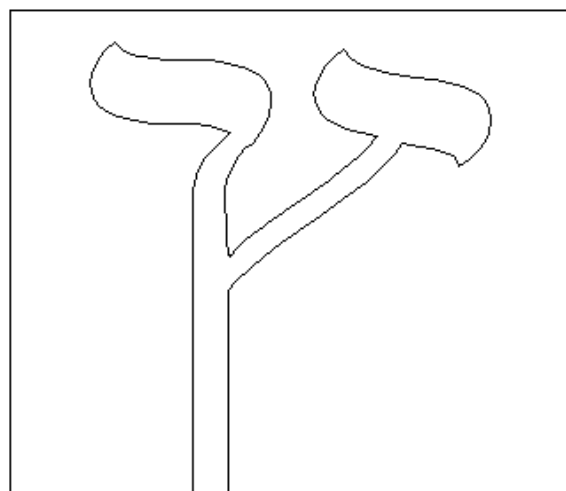

Tzadi	Tz	צֿ	צ = צִ
-------	----	----	--------

			
TZere	AE	..	צֵרֵי חָסֵר

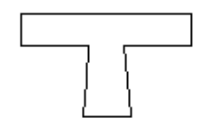
			
Kamatz	O	.	קָמָץ קָטָן

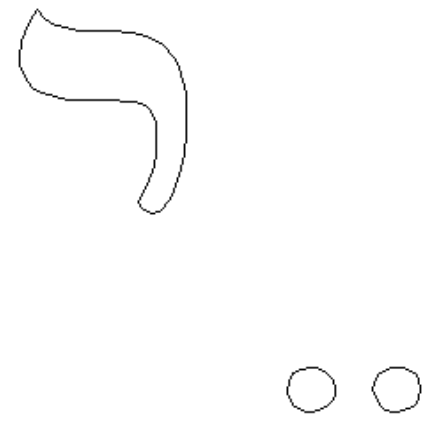
			
TZere	AE	..	צֵרֵי מְלֵא

			
Kubutz	U	..	קִבּוּץ

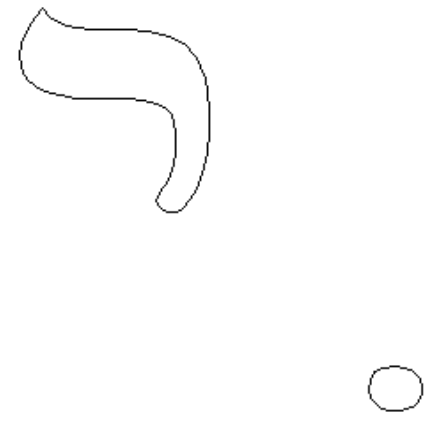
			
Chirik	I	.	חִירִיק מְלֵא

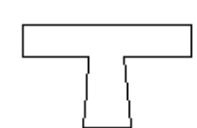
			
Kamatz	A	.	קָמָץ גָּדוֹל

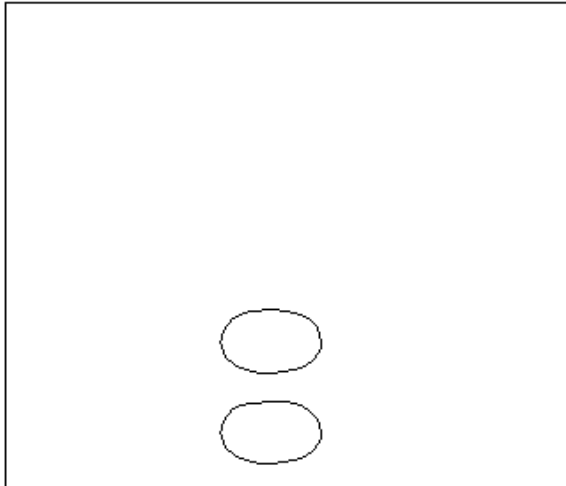

Sheva	,E	.	שְׁוָא
-------	----	---	--------

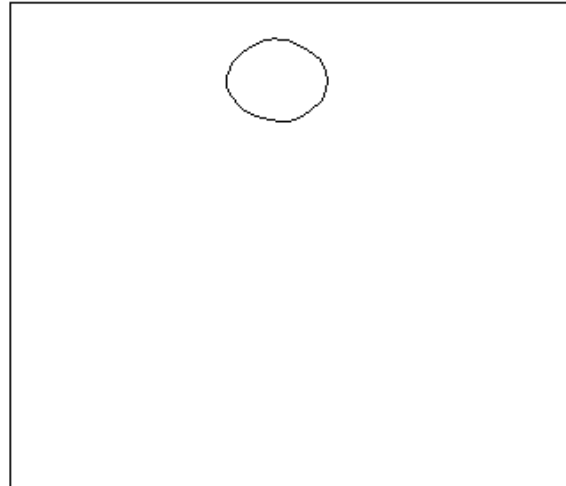

Cholam	O	.	חֹלָם קָסֵר
--------	---	---	-------------

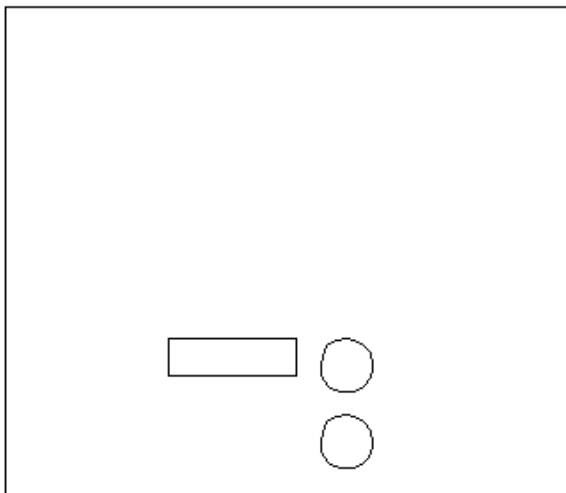

Chataf	A	.	חֲטַף פֶּתַח
--------	---	---	--------------

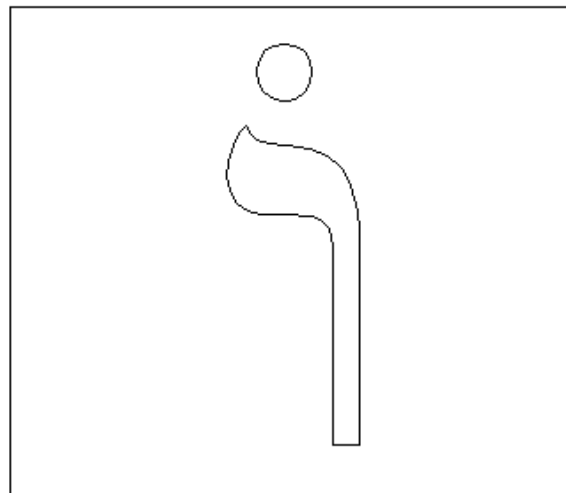

Cholam	O	i	חֹלָם מְלֵא
--------	---	---	-------------

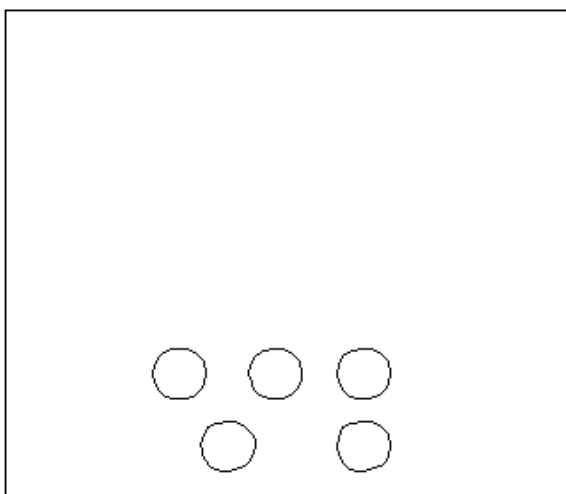

Chataf	E	.	חֲטַף סְגוּל
--------	---	---	--------------

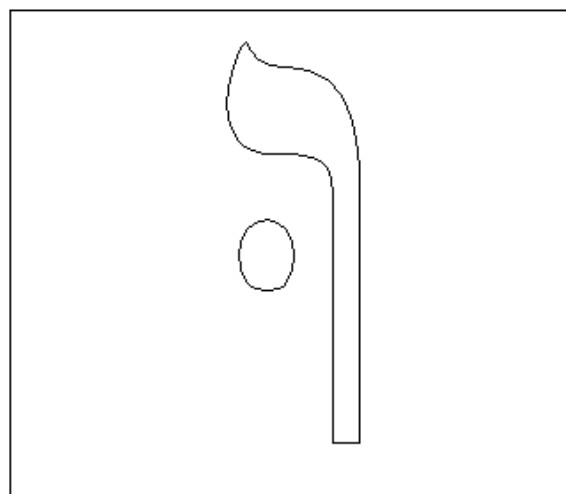

Shuruk	U	i	שׁוּרֻק
--------	---	---	---------

LETTERS			
Aleph		א	אָלֶף
Bet, Vet	B,V	ב	בֵּית
Gimel	G	ג	גִּמְלָל
Dalet	D	ד	דָּלֶת
He	H	ה	הָא
Vav	V	ו	וָו
Zain	Z	ז	זַיִן
Chet	Ch	ח	חֵית
Tet	T	ט	טֵית
Yod	I,Y	י	יּוֹד
Kaf, Chaf	K,Ch	כ	כָּף
Lamed	L	ל	לָמֶד
Mem	M	מ	מֶם
Nun	N	נ	נוּן
Samech	S	ס	סָמֶךְ
Ayin		ע	עַיִן
Fe, Pe	F,P	פ	פֵּא
Tzadi	Tz	צ	צָדִי
Kof	K	ק	קוּף
Reish	R	ר	רֵישׁ
Sin, Shin	S,Sh	ש	שַׁיִן
Tav	T	ת	תָּו

FINAL LETTERS			
Kaf	K	ך	כ = ך
Mem	M	ם	מ = ם
Nun	N	ן	נ = ן
Fe, Pe	F,P	ף	פ = ף
Tzadi	Tz	ץ	צ = ץ
VOWELS			
Patach	A	ַ	פָּתַח
Segol	E	ֶ	סֶגוֹל
Chirik	I	ִ	חִירִיק
Kamatz	O	ֹ	קָמָץ
Kubutz	U	ֻ	קֻבוּץ
Kamatz	A	ֵ	קָמָץ
Tzere	AE	ֵ	צֵרֵי
Tzere	AE	ֵ	צֵרֵי
Chirik	I	ִ	חִירִיק
Cholam	O	ׁ	חוֹלָם
Cholam	O	וּ	חוֹלָם
Shuruk	U	וּ	שׁוּרוּק
Sheva	,E	ְ	שֶׁוּא
Chataf pataj	A	ֶ	חֲטָף
Chataf segol	E	ֶ	חֲטָף
Chataf kamatz	O	ֶ	חֲטָף